



Victorian Install Guide/Concepts

Victorian is a historic metal shingle - details shown may not be applicable in some scenarios. Custom trim details are available for proper match on historic buildings.

800-728-4010
bestbuymetals.com

Victorian - Trim Profiles

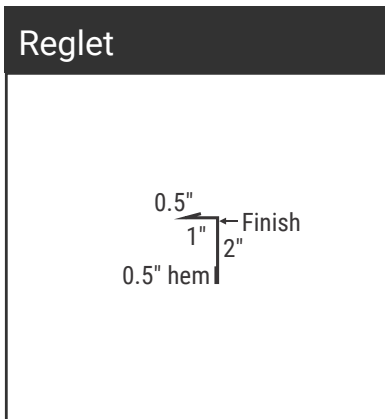
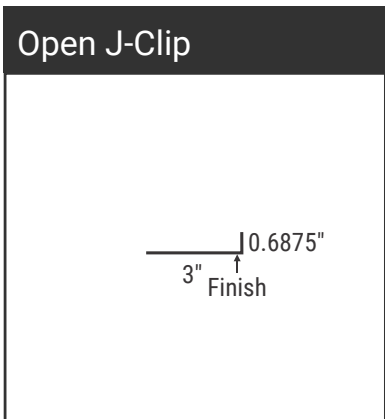
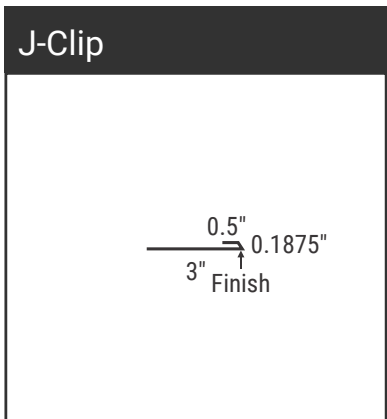
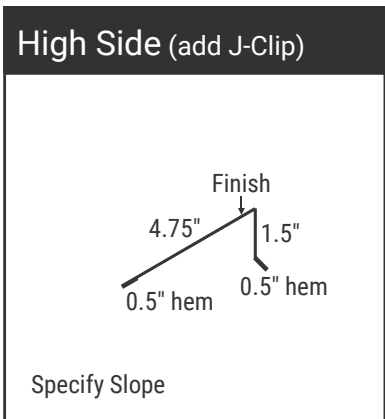
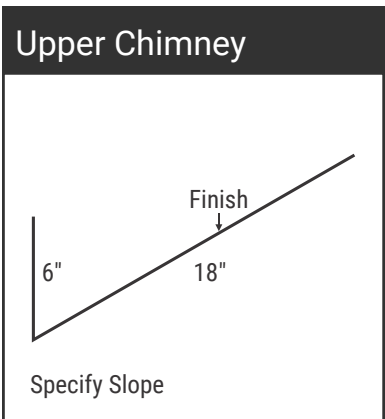
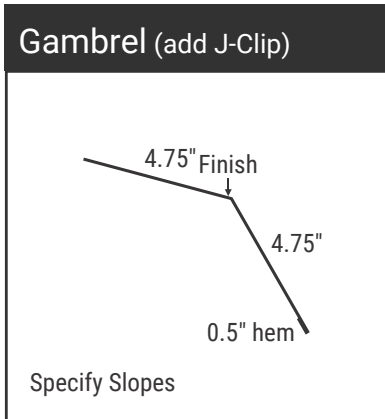
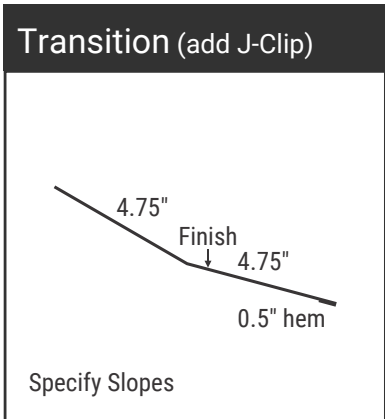
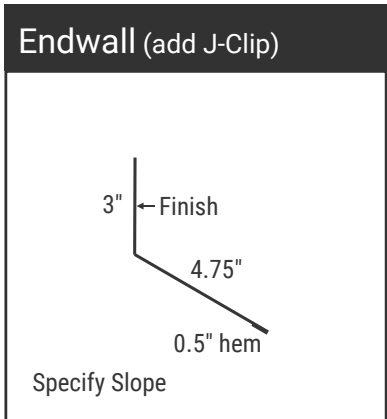
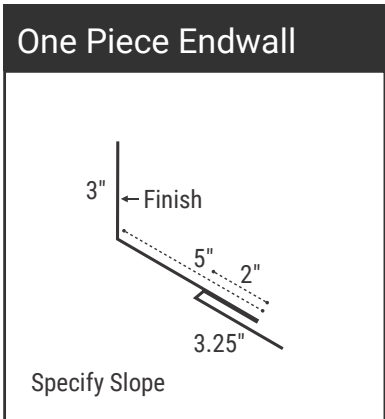
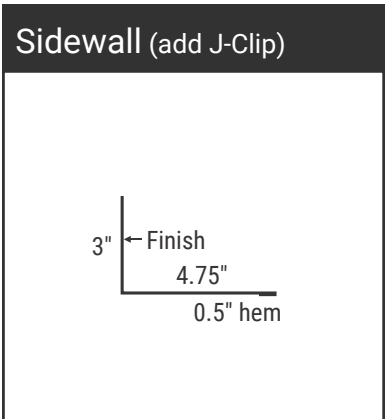
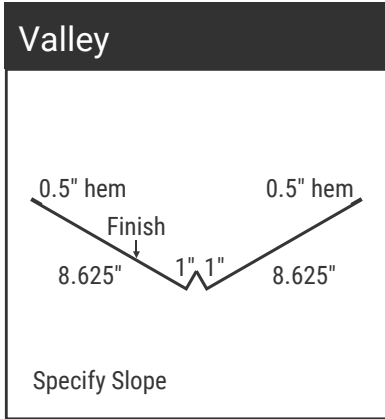
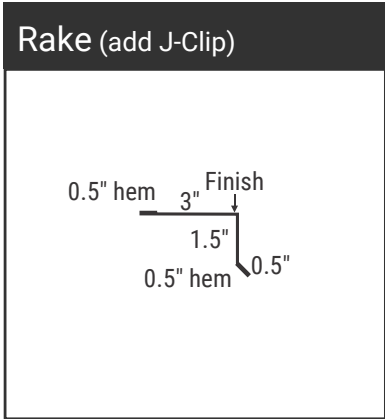
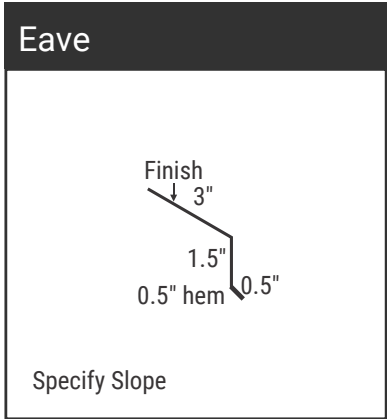
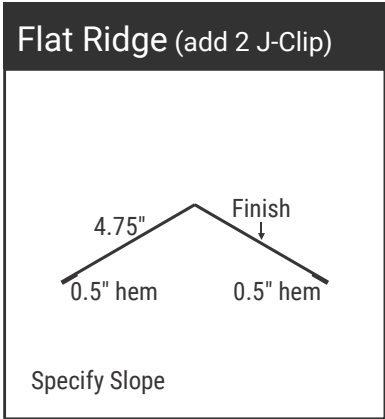
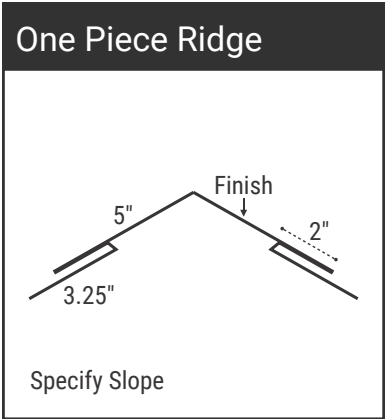

All trim is 10' long. Flat Sheets and custom trim are available.

Victorian - Install Sequence

(1) Victorian is a water shedding roof system - not a water-tight roof system. As such, Ice & Water shield must be installed over the entire roof surface prior to installation.

(2) Victorian locks right to left. Because of it's historic design, Victorian does not have the 4-way interlock found on most of our other metal shingles.

(3) Victorian is not recommended for slopes under 4:12, nor over existing shingles.



Gable Roof (shown uses One Piece Ridge)

- a. Install **Eave**
- b. Install **Rake**
- c. Install **J-Clip** on starting rake edge (left if looking at roof toward the eave from the ground) and **Open J-Clip** on ending rake edge (right if looking at roof toward the eave from the ground).
- d. Install **One Piece Ridge** at ridges - each will need the bottom open hem flange removed before lapping.
- e. Install **Ice & Water Shield** over entire roof, lapping over Eave and J-Clip by 2" - 2.5". At ridge, final row of Ice & Water Shield should tuck inside open hem flange if possible.
- f. Install **Victorian Shingles** from left to right, with the first shingle tucked into the J-Clip and extending over the Eave by 1/4" - 1/2".
- g. **Stagger rows** by 1/2 shingle. **Chalk lines** between each row to keep rows straight. When needed adjust the bottom shingle to **keep the top aligned** with the chalk line. (Keep at least 75% of any specific shingle engaged).
- h. **Fold down hem** on Open J-Clip at ending rake.

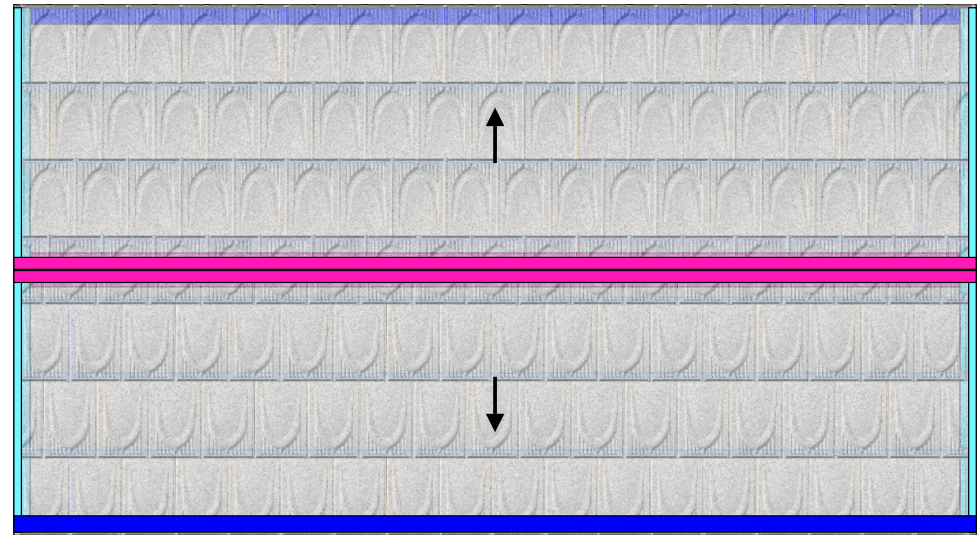

Hip Roof with Dormer (shown uses One Piece Ridge)

- a. Install **Eave**
- b. Install **Rake**
- c. Install **Sidewall**
- d. Install **J-Clip** on starting rake and sidewall edges (left if looking at roof toward the eave from the ground) and **Open J-Clip** on ending rake and sidewall edge (right if looking at roof toward the eave from the ground).
- e. Install **One Piece Ridge** on hips - each will need the bottom open hem flange removed before lapping.
- f. Install **Ice & Water Shield** over entire roof, lapping over Eave and J-Clip by 2" - 2.5". At ridges/hips, final row of Ice & Water Shield should tuck inside open hem flange if possible.
- g. Install **Victorian Shingles** on main roof up to level of valley on dormer.
- h. Install valley over shingles on main roof, overlapping at top.
- i. Install **One Piece Ridge** on both dormer and main roof ridges - each will need the bottom open hem flange removed before lapping. On dormer, ridge will go over valleys and the top section flattened to fit under shingles on main roof.
- j. Install **Victorian Shingles** on the remainder of main roof and dormer.
- k. **Fold down hem** on Open J-Clip at ending rake and sidewall.

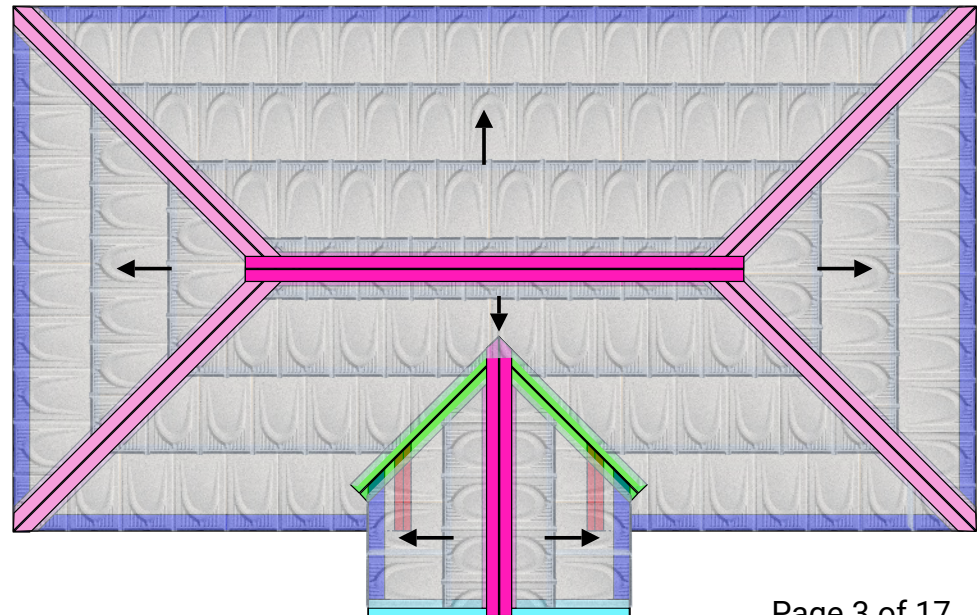

Victorian - Ridge or Hip: One Piece Ridge

Ridge	Hip	Eave	Rake	Valley	Sidewall	Endwall	Transition	Upper Chimney	Upper Skylight	High Side	Flying Rafter	Gambrel	Short Course	Panel Overlap (n/a)
-------	-----	------	------	--------	----------	---------	------------	---------------	----------------	-----------	---------------	---------	--------------	---------------------

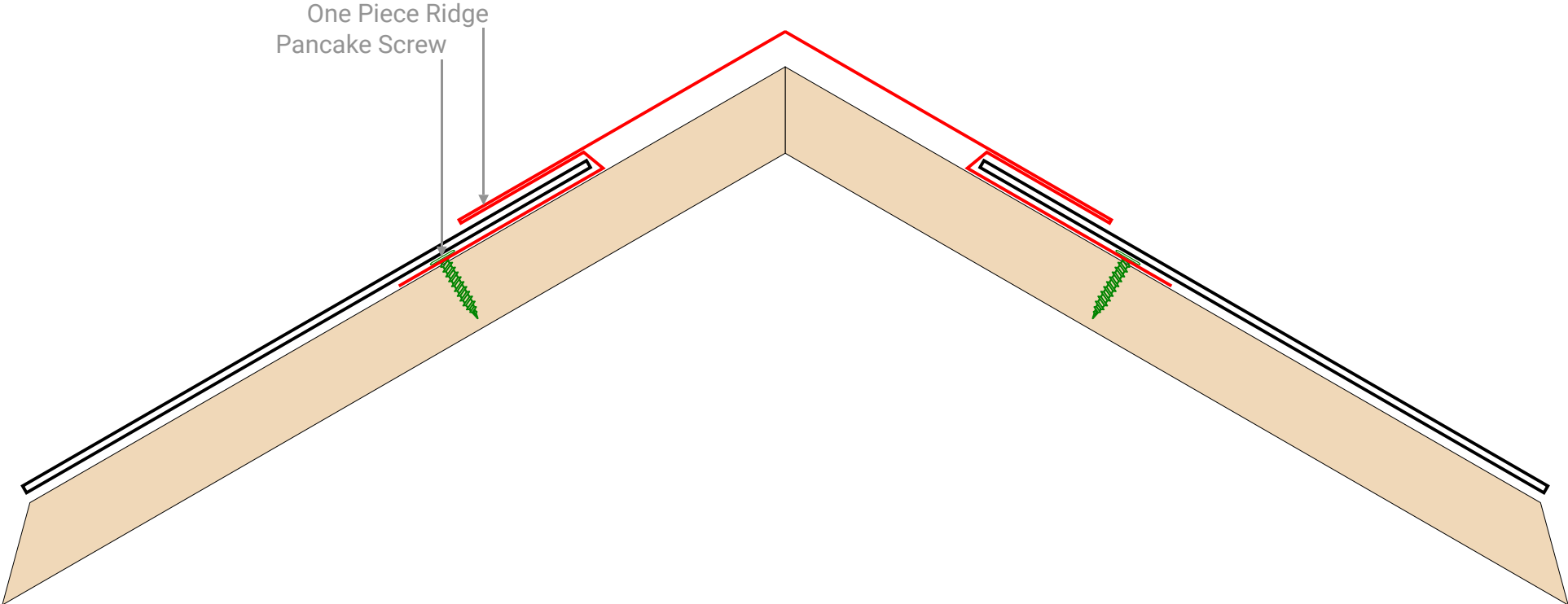

Victorian - Ridge or Hip: Flat Ridge

Ridge	Hip	Eave	Rake	Valley	Sidewall	Endwall	Transition	Upper Chimney	Upper Skylight	High Side	Flying Rafter	Gambrel	Short Course	Panel Overlap (n/a)
-------	-----	------	------	--------	----------	---------	------------	---------------	----------------	-----------	---------------	---------	--------------	---------------------

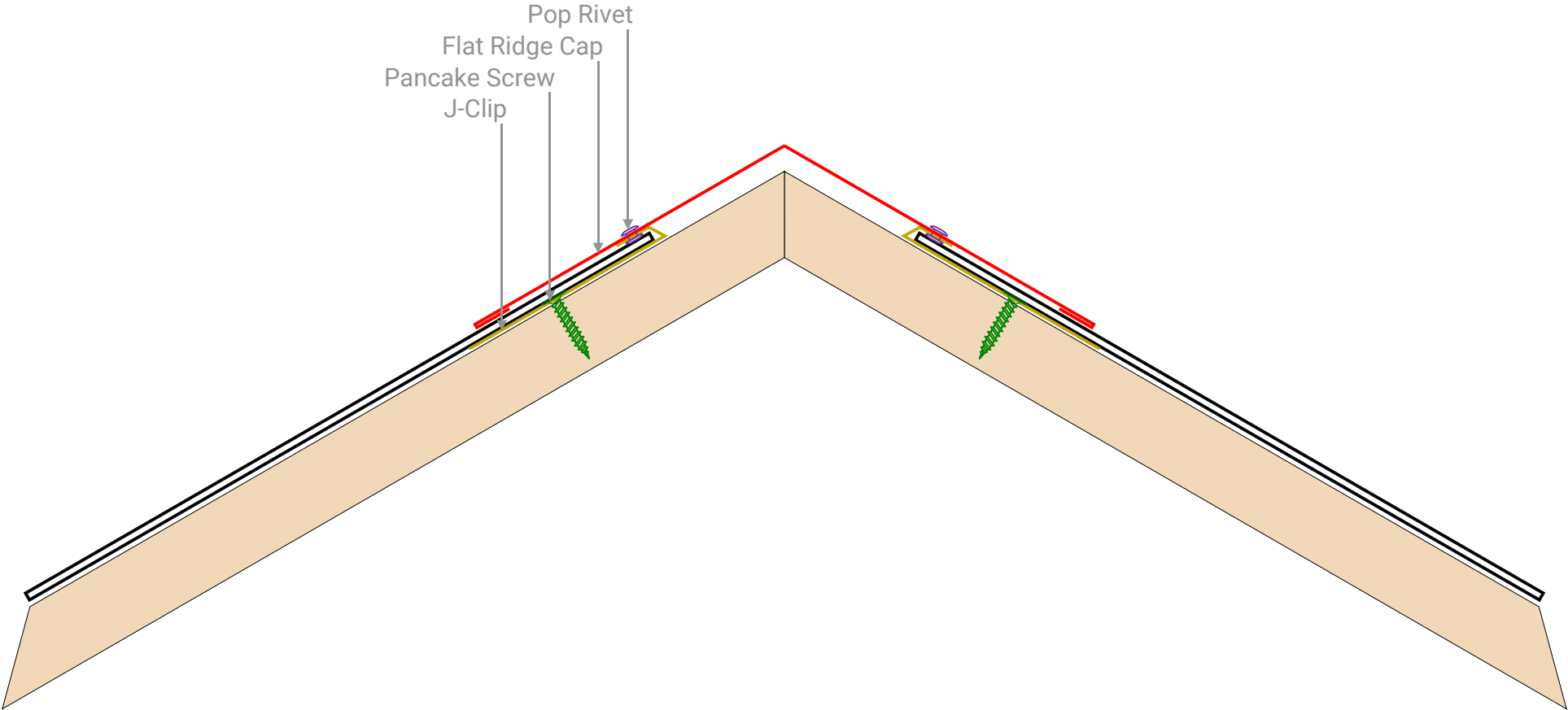

Victorian - Eave

Ridge
Hip
Eave
Rake
Valley
Sidewall
Endwall
Transition
Upper Chimney
Upper Skylight
High Side
Flying Rafter
Gambrel
Short Course
Panel Overlap (n/a)

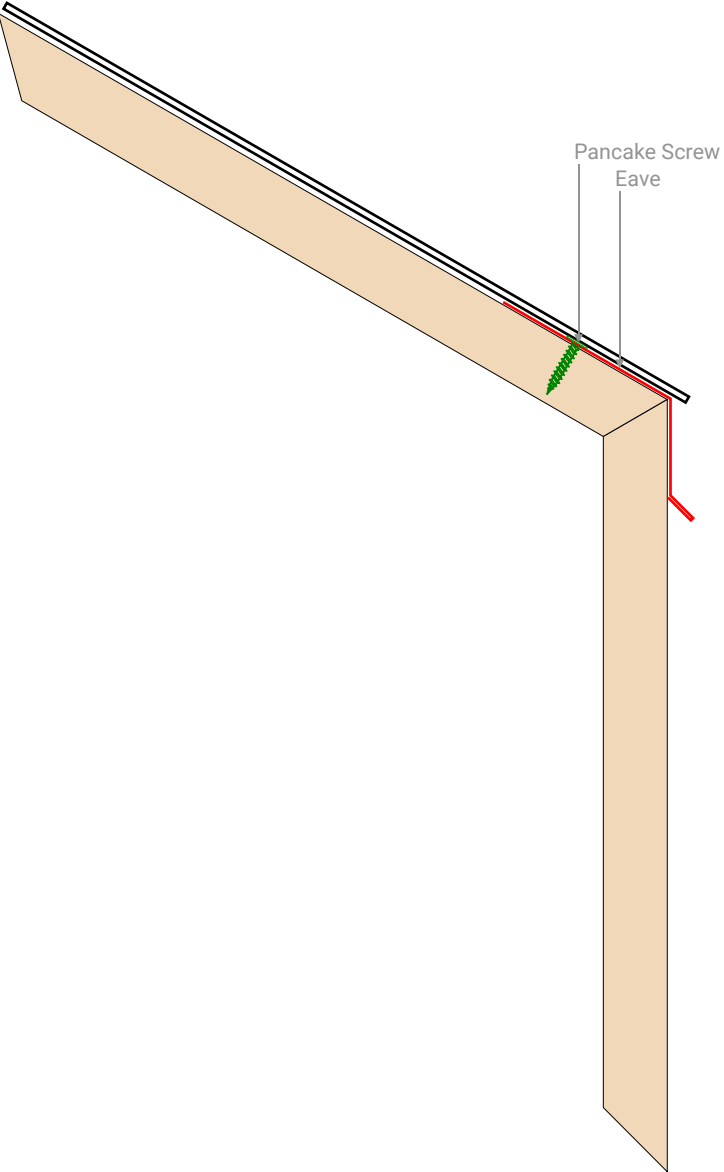

Victorian - Gable/Rake

Ridge	Hip	Eave	Rake	Valley	Sidewall	Endwall	Transition	Upper Chimney	Upper Skylight	High Side	Flying Rafter	Gambrel	Short Course	Panel Overlap (n/a)
-------	-----	------	------	--------	----------	---------	------------	---------------	----------------	-----------	---------------	---------	--------------	---------------------

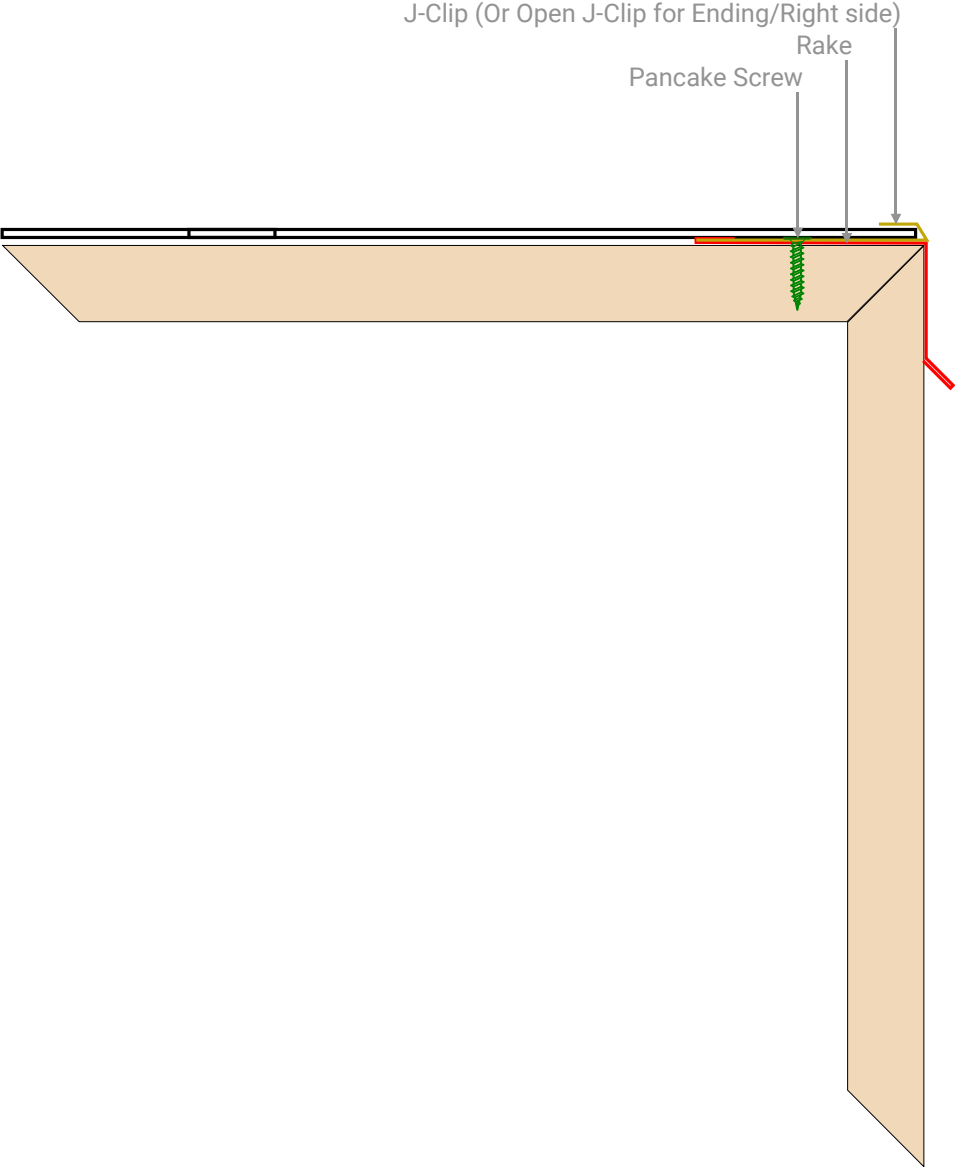

Victorian - Valley

Ridge
Hip
Eave
Rake
Valley
Sidewall
Endwall
Transition
Upper Chimney
Upper Skylight
High Side
Flying Rafter
Gambrel
Short Course
Panel Overlap (n/a)

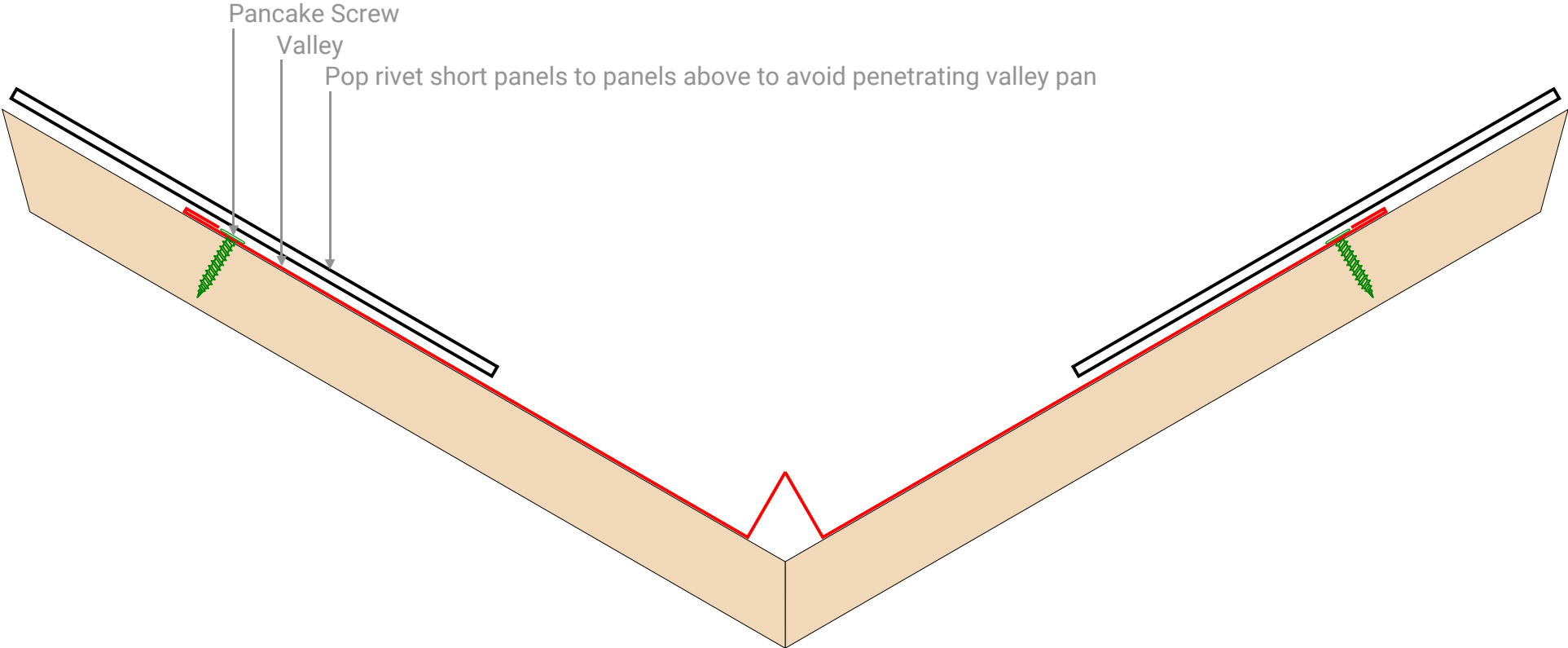

Victorian - Sidewall

Ridge	Hip	Eave	Rake	Valley	Sidewall	Endwall	Transition	Upper Chimney	Upper Skylight	High Side	Flying Rafter	Gambrel	Short Course	Panel Overlap (n/a)
-------	-----	------	------	--------	-----------------	---------	------------	---------------	----------------	-----------	---------------	---------	--------------	---------------------

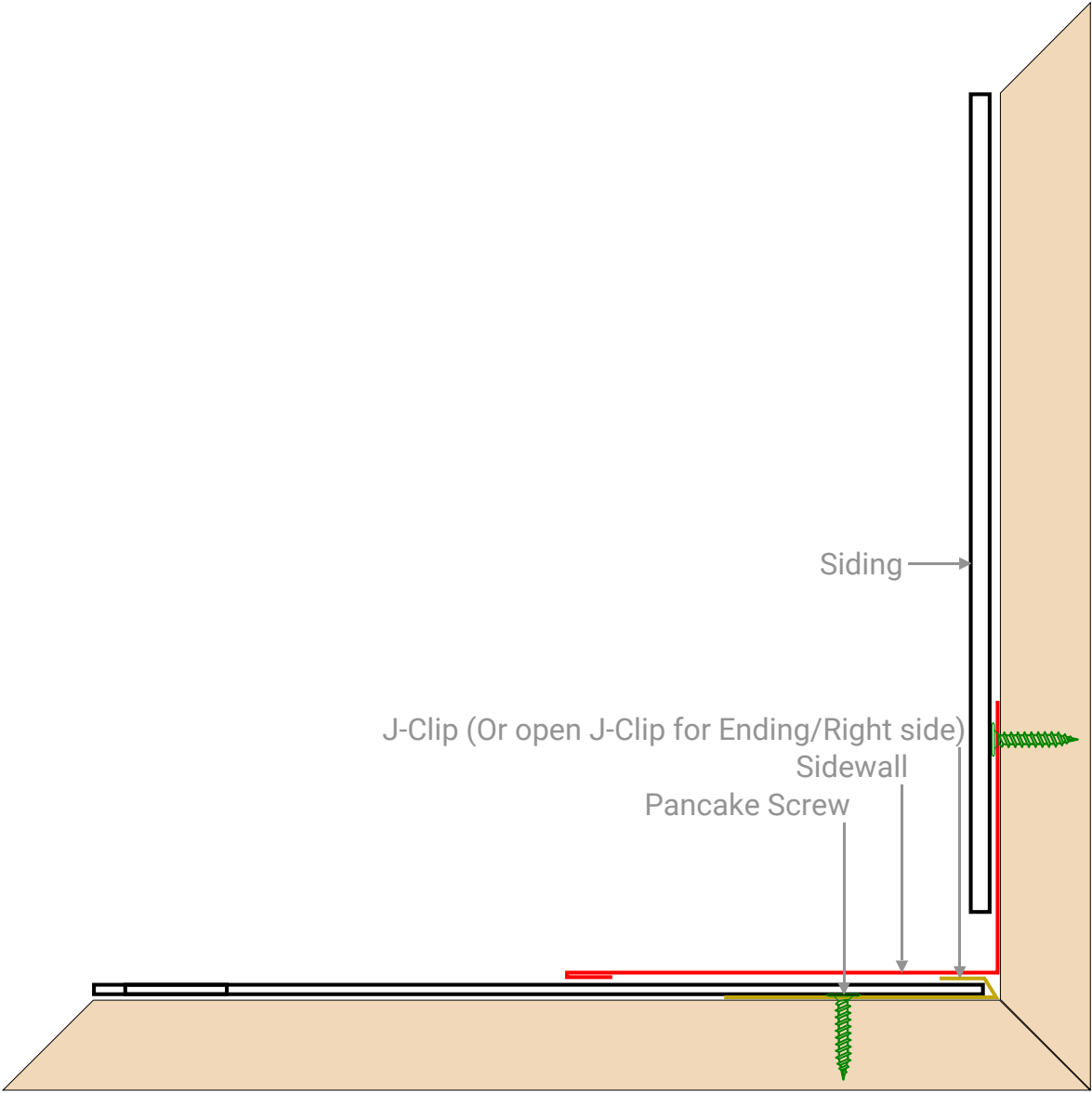

Victorian - Endwall: One Piece Endwall

Ridge
Hip
Eave
Rake
Valley
Sidewall
Endwall
Transition
Upper Chimney
Upper Skylight
High Side
Flying Rafter
Gambrel
Short Course
Panel Overlap (n/a)

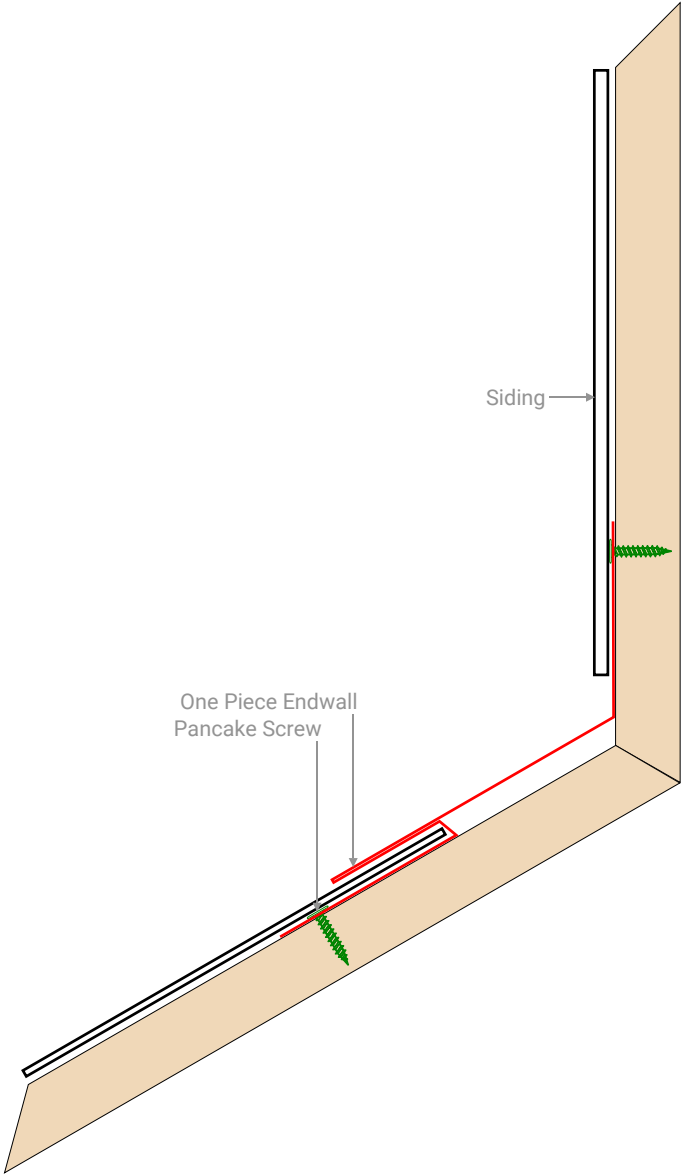

Victorian - Endwall: Simple Endwall

Ridge
Hip
Eave
Rake
Valley
Sidewall
Endwall
Transition
Upper Chimney
Upper Skylight
High Side
Flying Rafter
Gambrel
Short Course
Panel Overlap (n/a)

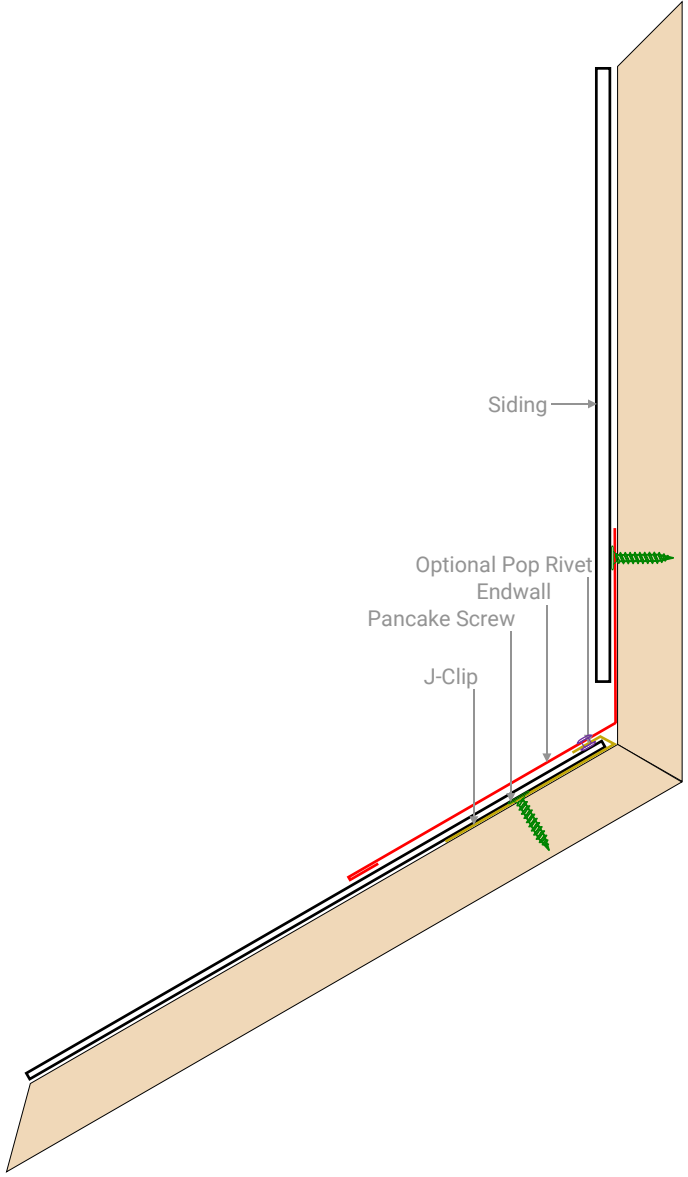

Victorian - Transition

Ridge	Hip	Eave	Rake	Valley	Sidewall	Endwall	Transition	Upper Chimney	Upper Skylight	High Side	Flying Rafter	Gambrel	Short Course	Panel Overlap (n/a)
-------	-----	------	------	--------	----------	---------	-------------------	---------------	----------------	-----------	---------------	---------	--------------	---------------------

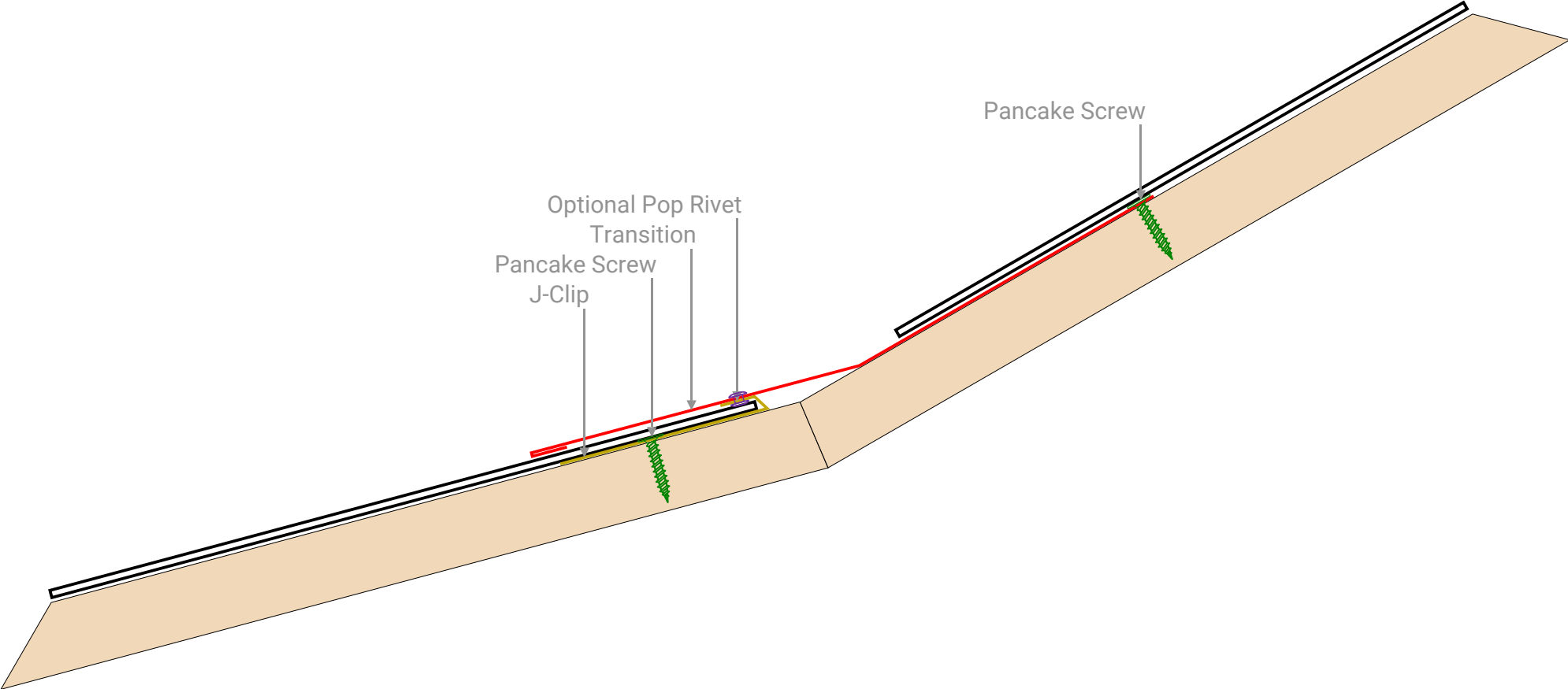

Victorian - Upper Chimney

Ridge
Hip
Eave
Rake
Valley
Sidewall
Endwall
Transition
Upper Chimney
Upper Skylight
High Side
Flying Rafter
Gambrel
Short Course
Panel Overlap (n/a)

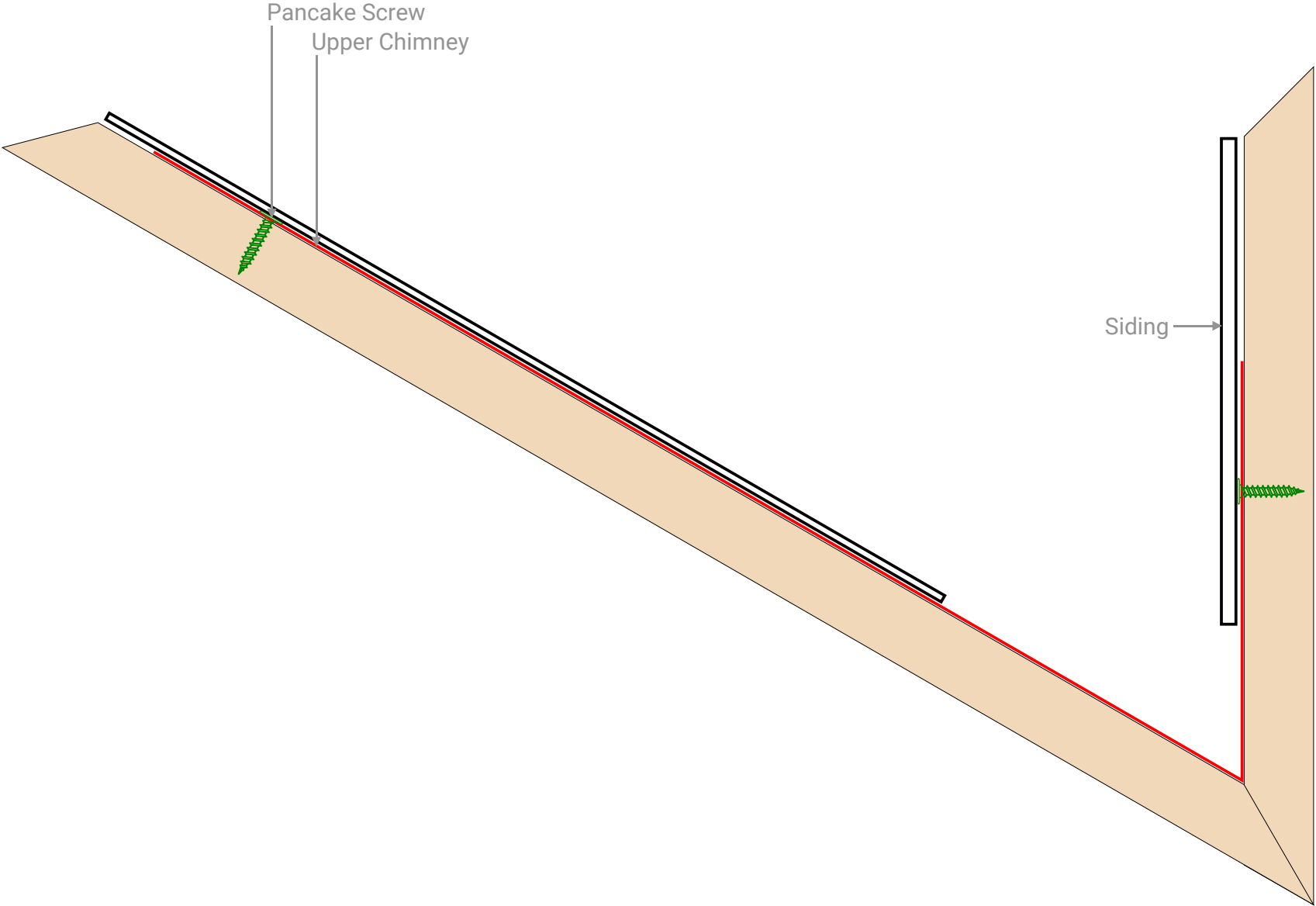

Victorian - Upper Skylight

Ridge	Hip	Eave	Rake	Valley	Sidewall	Endwall	Transition	Upper Chimney	Upper Skylight	High Side	Flying Rafter	Gambrel	Short Course	Panel Overlap (n/a)
-------	-----	------	------	--------	----------	---------	------------	---------------	----------------	-----------	---------------	---------	--------------	---------------------

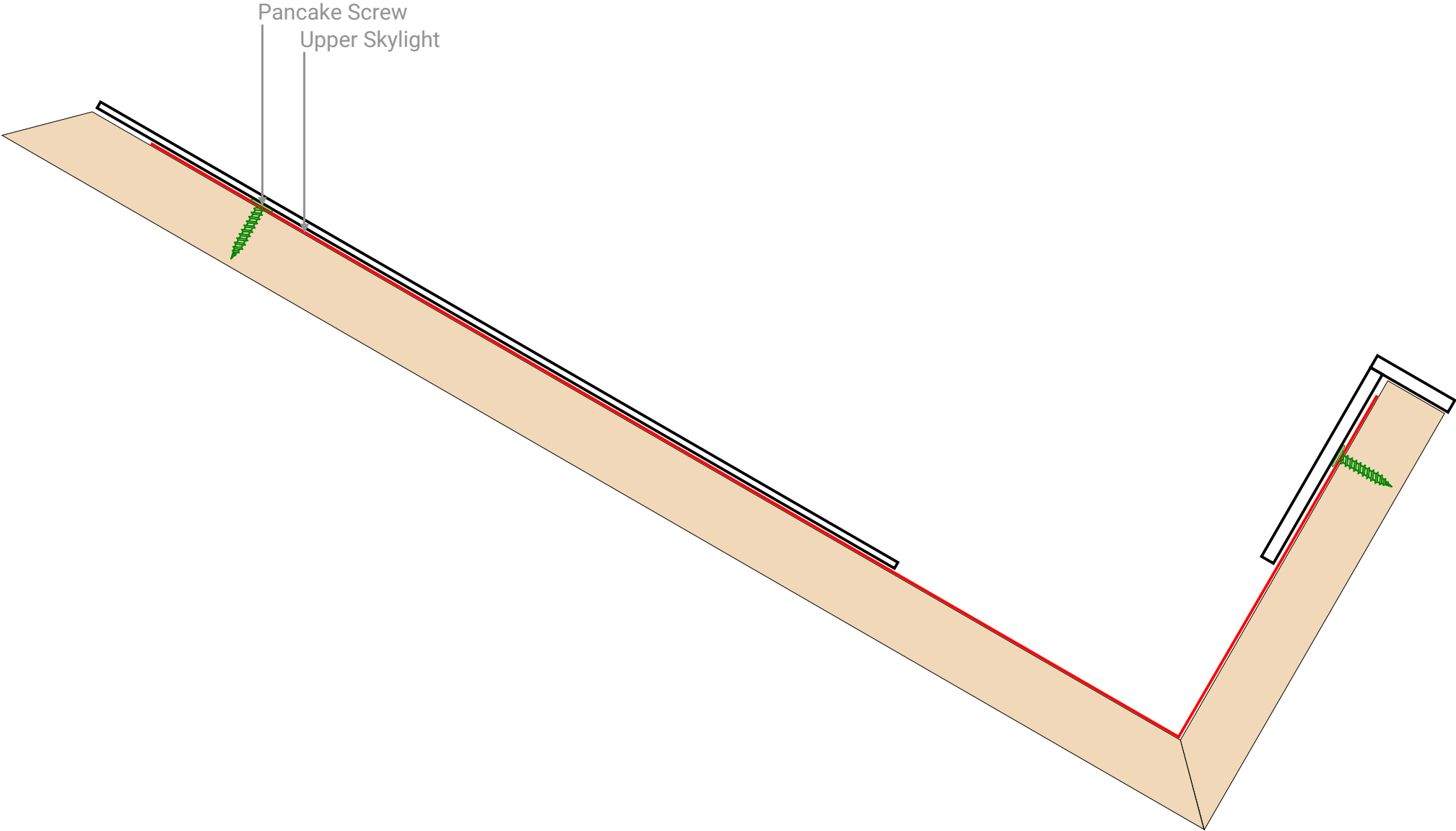

Victorian - High Side

Ridge
Hip
Eave
Rake
Valley
Sidewall
Endwall
Transition
Upper Chimney
Upper Skylight
High Side
Flying Rafter
Gambrel
Short Course
Panel Overlap (n/a)

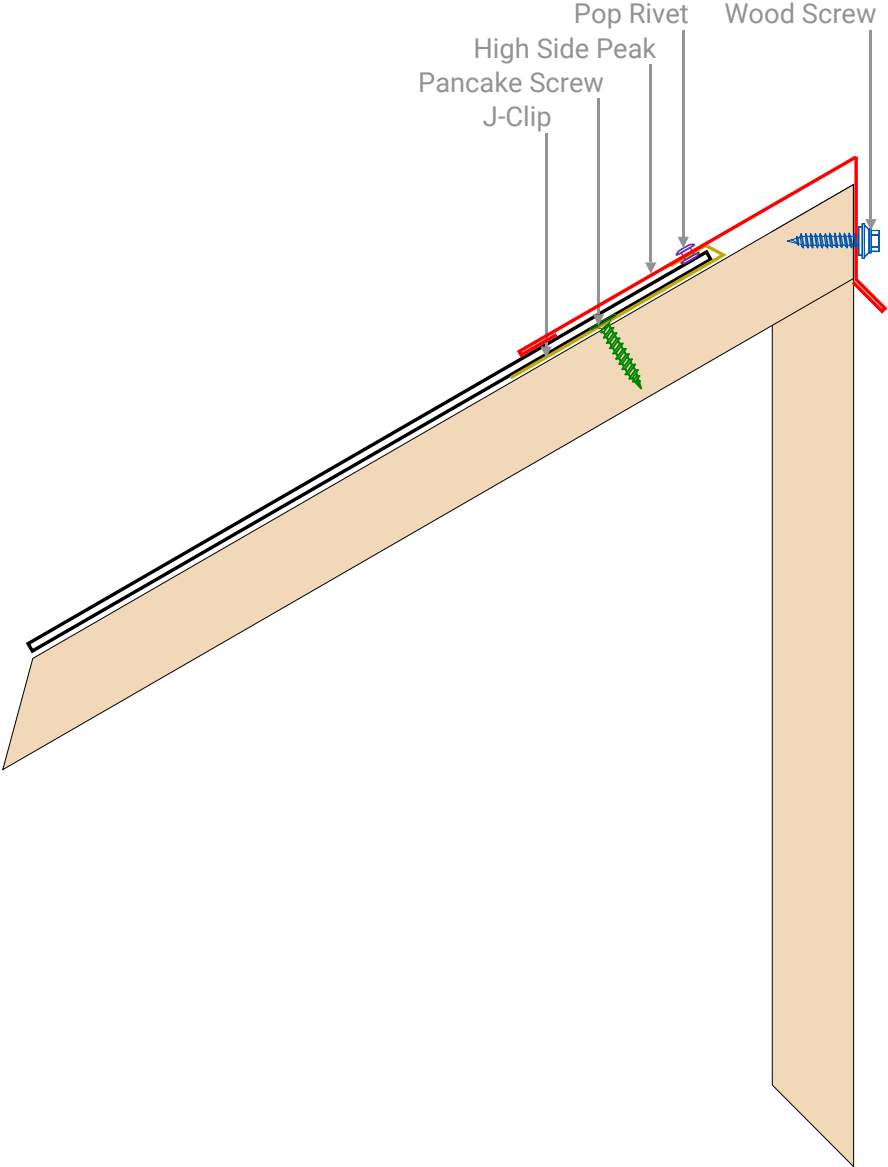

Victorian - Gambrel

Ridge	Hip	Eave	Rake	Valley	Sidewall	Endwall	Transition	Upper Chimney	Upper Skylight	High Side	Flying Rafter	Gambrel	Short Course	Panel Overlap (n/a)
-------	-----	------	------	--------	----------	---------	------------	---------------	----------------	-----------	---------------	----------------	--------------	---------------------

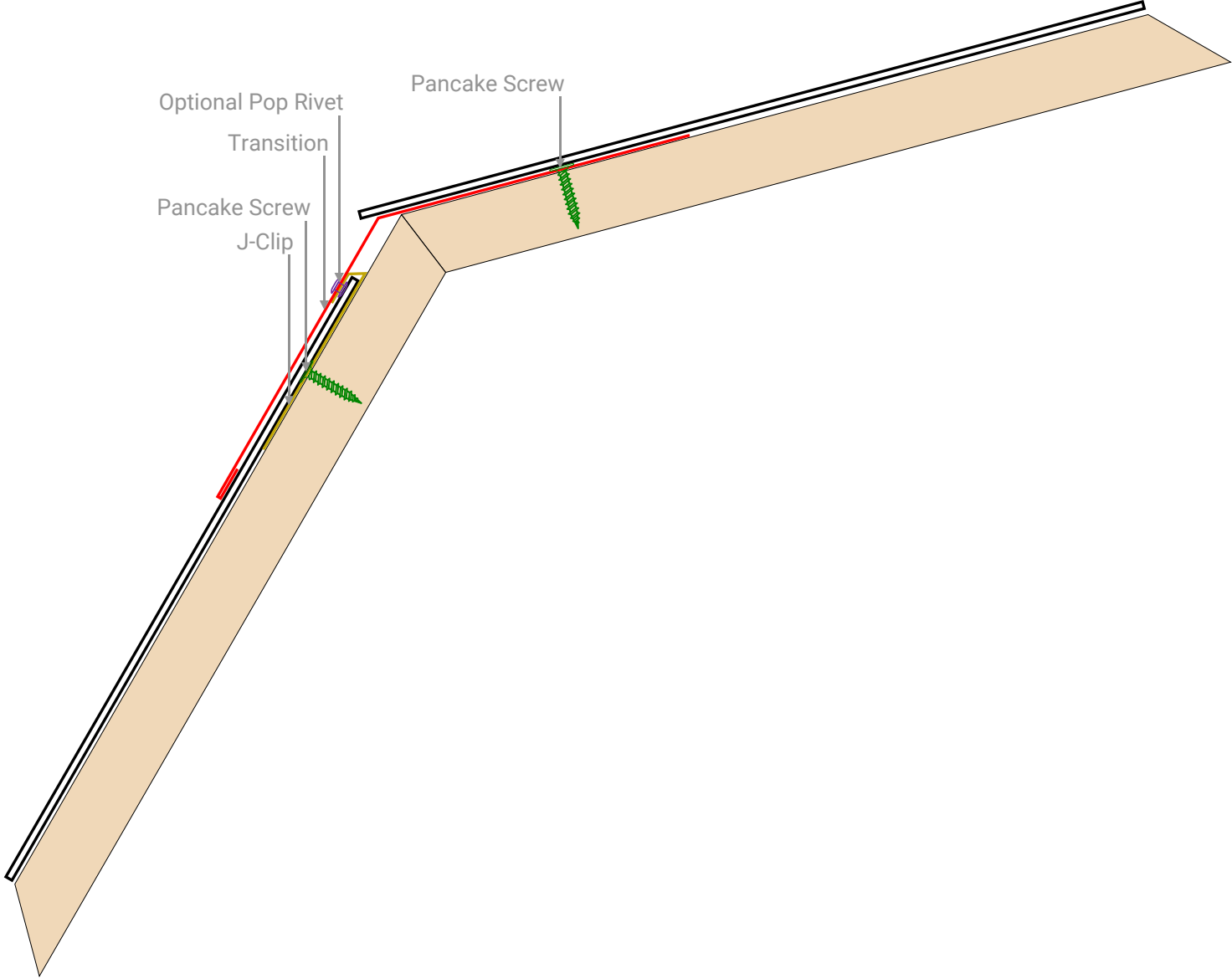



Metal Roofing, Nationwide

800-728-4010
bestbuymetals.com