

IMPORTANT INFORMATION

The application and detail drawings in this manual are strictly for illustration purposes and may not be applicable to all building designs or product installations. All projects should conform to applicable building codes for that particular area. It is recommended to follow all building regulations and standard industry practices.

Prior to ordering and installing materials, all dimensions should be verified by field measurements.

Oil canning is not a cause for rejection. Oil canning can be described as the amount of waviness found in the flat areas of metal panels. Oil canning is an inherent characteristic of light gauge cold formed metal products, particularly those with broad flat areas. There are many factors which may contribute to oil canning that the plant is not able to control. These factors include: misalignment of the support system, over driving of fasteners used on the panels, stress (whether inherent in the panel or induced), thermal expansion and contraction of the panel, material handling, width, gauge, length, color of panels, and installation. (Reference Metal Construction Association "Oil Canning Position Paper" - Appendix A).

Consult your representative for any additional information not outlined in this manual. This manual is designed to be utilized as a guide when installing steel soffit systems. It is the responsibility of the erector to ensure the safe installation of this product system.

SAFETY

The installation of soffit & wall systems is a dangerous procedure and should be supervised by trained knowledgeable erectors. **USE EXTREME CARE WHILE INSTALLING PANELS.** It is not possible for us to be aware of all the possible job site situations that could cause an unsafe condition to exist. The erector of the roof system is responsible for reading these instructions and determining the safest way to install the system.

These instructions are provided only as a guide to show a knowledgeable, trained erector the correct parts placement one to another. If following any of the installation steps would endanger a worker, the erector should stop work and decide upon a corrective action.

Provide required fall protection as required.

CONTENT

PAGE

Overview	1
Panels	2
Soffit / Ceiling - Overhang	3-4
Soffit / Ceiling - Joint	5-6
Soffit / Ceiling - Narrow Angle	7
Soffit / Ceiling - Inside Ridge	9
Wall - Inside Corner	10
Wall - Outside Corner	11
Wall - Windows and Doors	12
Wall - Bottom of Wall	13-14

This guide does not cover all aspects of installation. Ask your representative if your detail is different. Panel Caps or Zee Closures can often be used interchangeably, and may make installation easier even if not shown in the illustration.

INSTALLING FIRST PANEL

Note: Moisture Barriers and Jamb flashings must first be installed before panel installation can begin. Soffit panels are installed from left to right or right to left.

Install first panel making sure that panel is square to the soffit, fascia, or wall. **It is critical that the first panel be straight and square with the building as it controls alignment of the following panels.** Fasten panel typically with pancake head woodscrews (12" o.c. typical) in center of the fastening groove and make sure not to overtighten screws. For areas with high wind considerations, closer fastener spacing may be required.

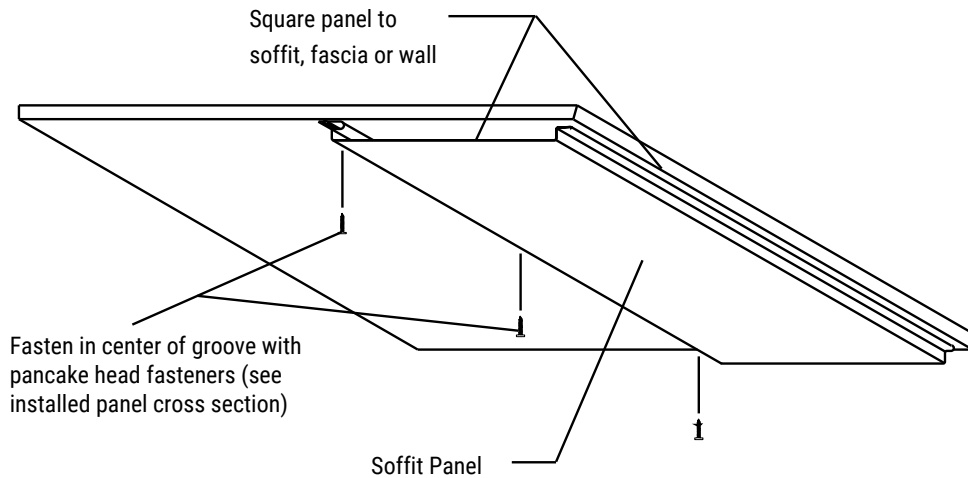

INSTALLING SECOND PANEL

Position tongue of second panel into the groove of the first, making sure panel ends are aligned and continue with previous steps until installation is complete. Make sure all panels are properly installed, and clean any debris from panel before continuing to next area.

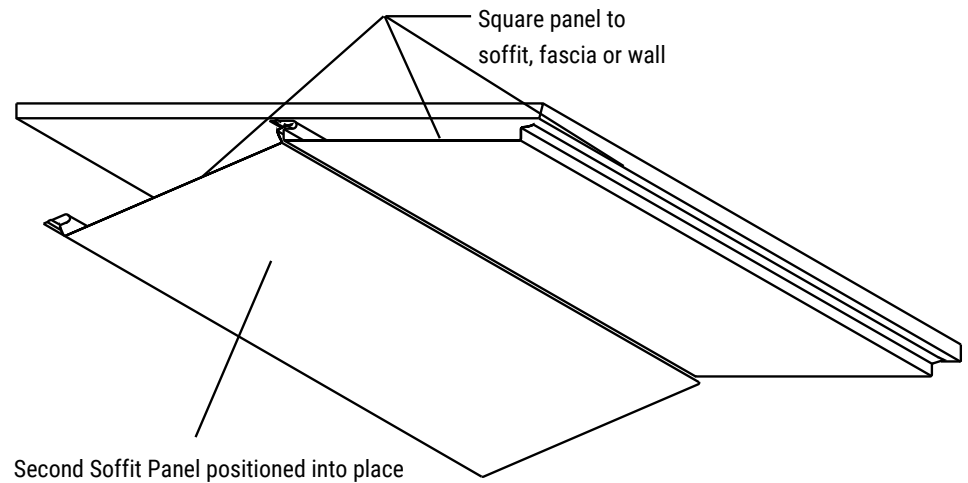

FASTENING

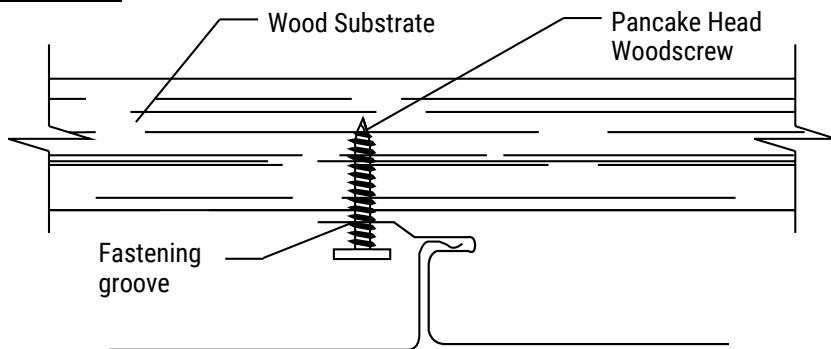

INSTALLED PANEL CROSS SECTION

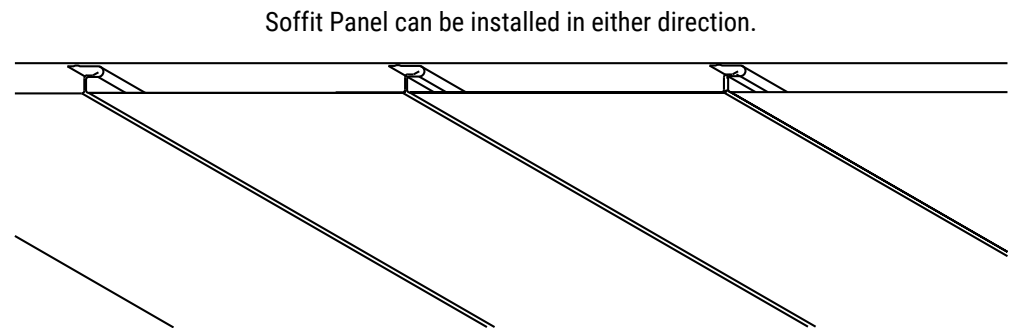

- 1) Install J-Channel using Pancake Screws.
- 2) Install Soffit Panels, either horizontally or vertically, tucking them inside the J-Channel.
- 3) Install Fascia Trim over end, capping the end of the shingles and going up the fascia, and fastening with Wood Screws.

Color Guide

-  Panel
-  J-Channel
-  Fascia (sizes vary)
-  Pancake Screw
-  Wood Screw

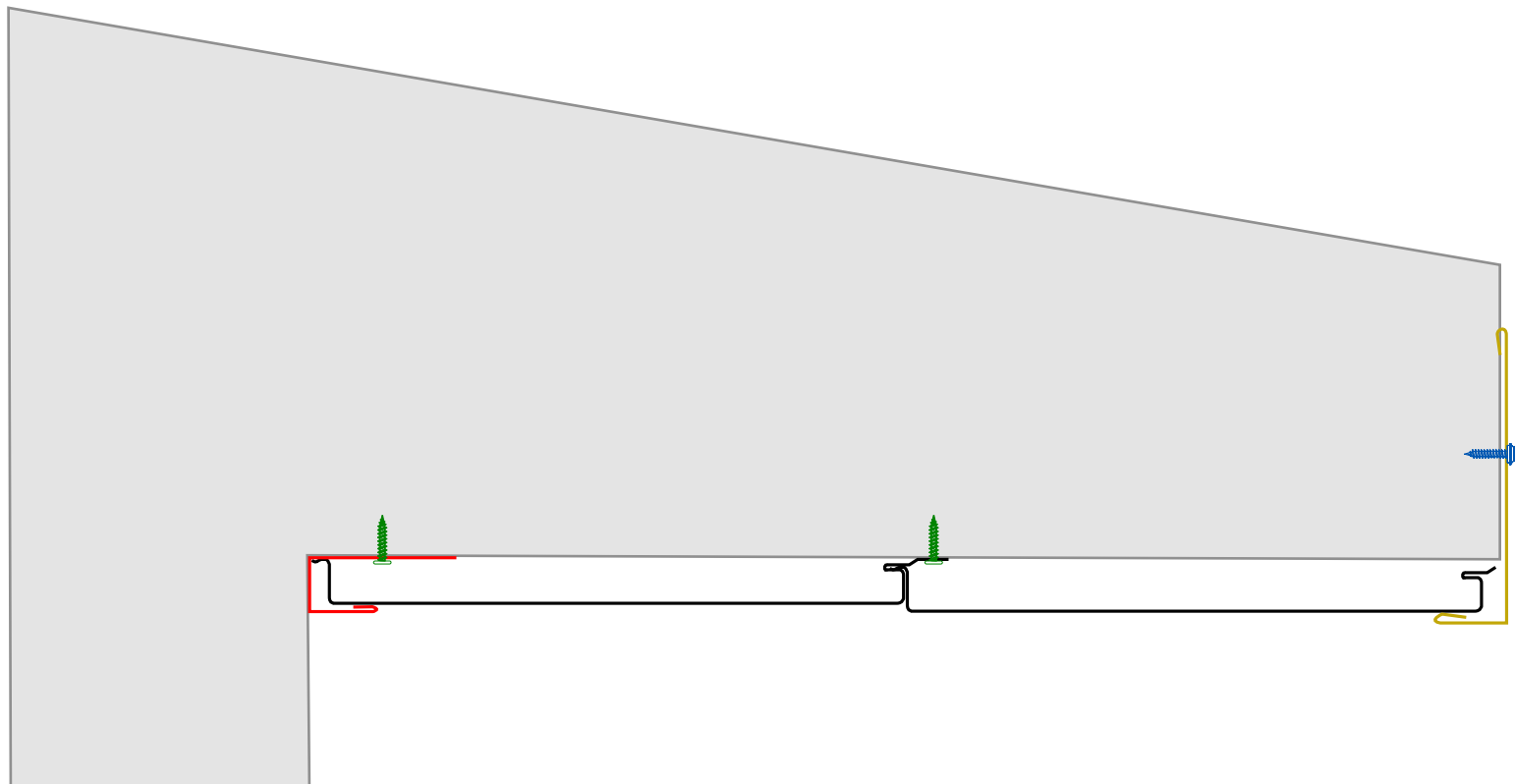

- 1) Install J-Channel on both sides using Pancake Screws.
- 2) Install Soffit Panels, either horizontally or vertically, tucking them inside the J-Channel. On the fascia side, pop rivets may be used to hold them tight to the j-channel if needed.

Color Guide

- Panel
- J-Channel
- Pancake Screw
- Wood Screw
- Pop Rivet

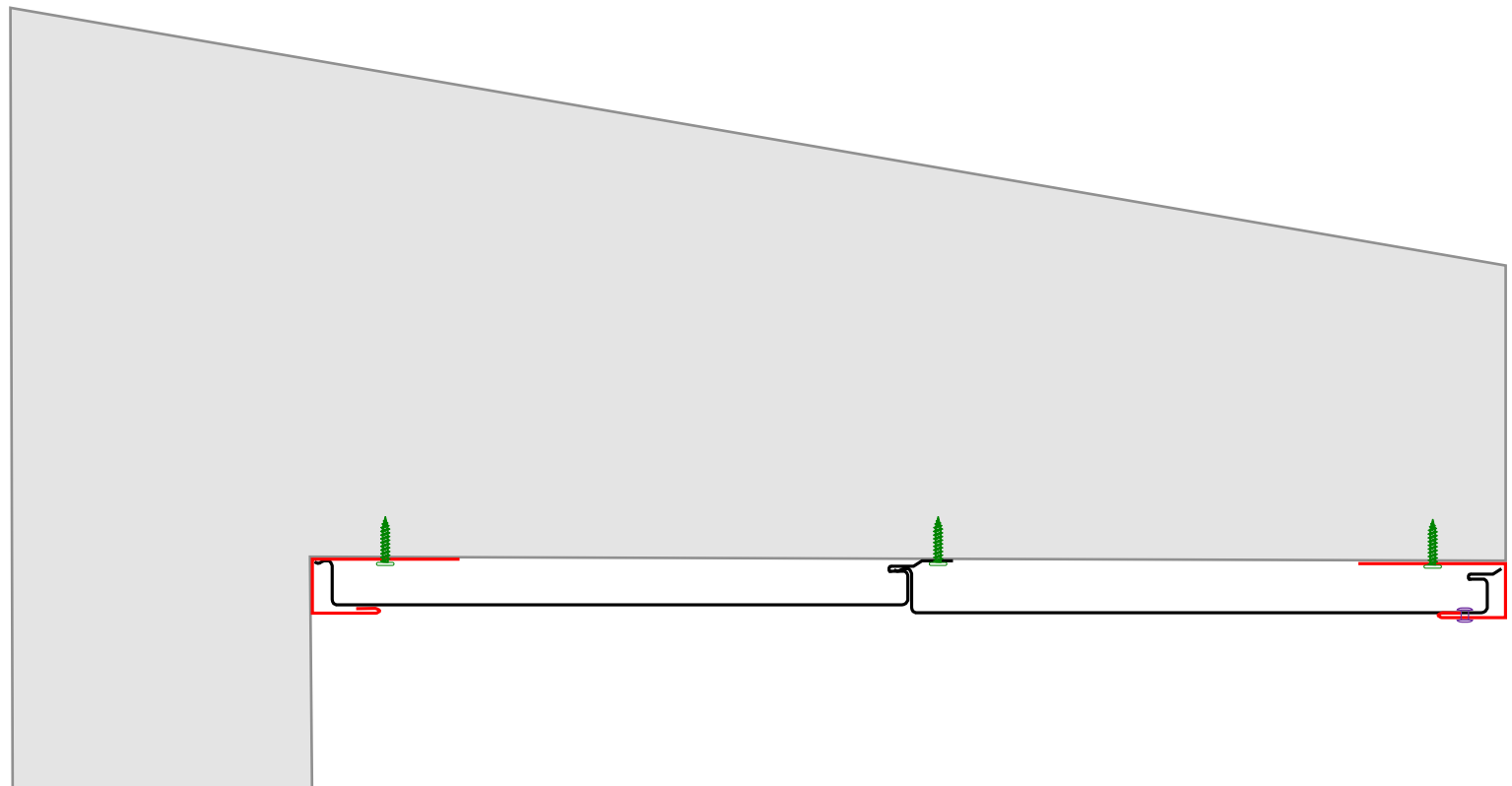

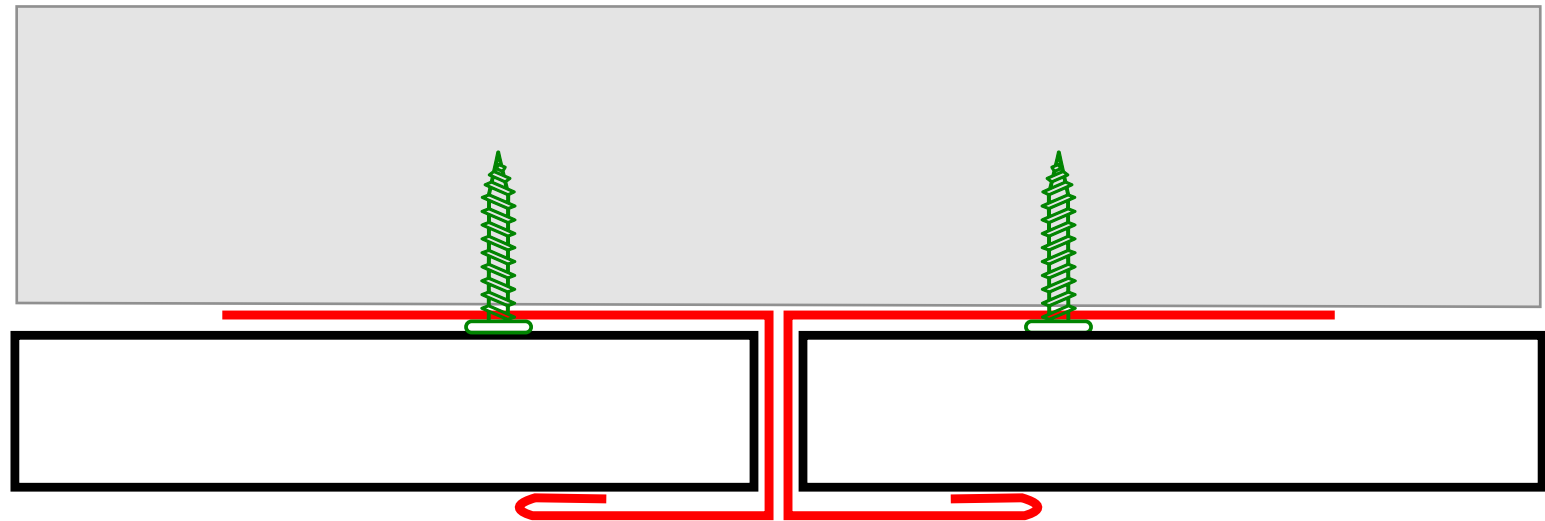
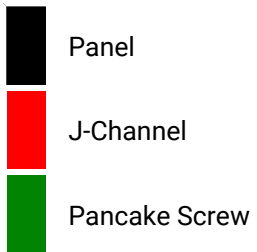

- 1) Install J-Channel, butted together, and fastened using Pancake Screws.
- 2) Install Soffit Panels, either horizontally or vertically, tucking them inside the J-Channel. Pop rivets may be used to hold them tight to the j-channel if needed.

Color Guide



- 1) Install Soffit Panels, either horizontally or vertically.
- 2) Install Custom Joint Trim, fastening with Pop Rivets.

Color Guide

-  Panel
-  Custom Joint Trim
-  Pancake Screw
-  Pop Rivet

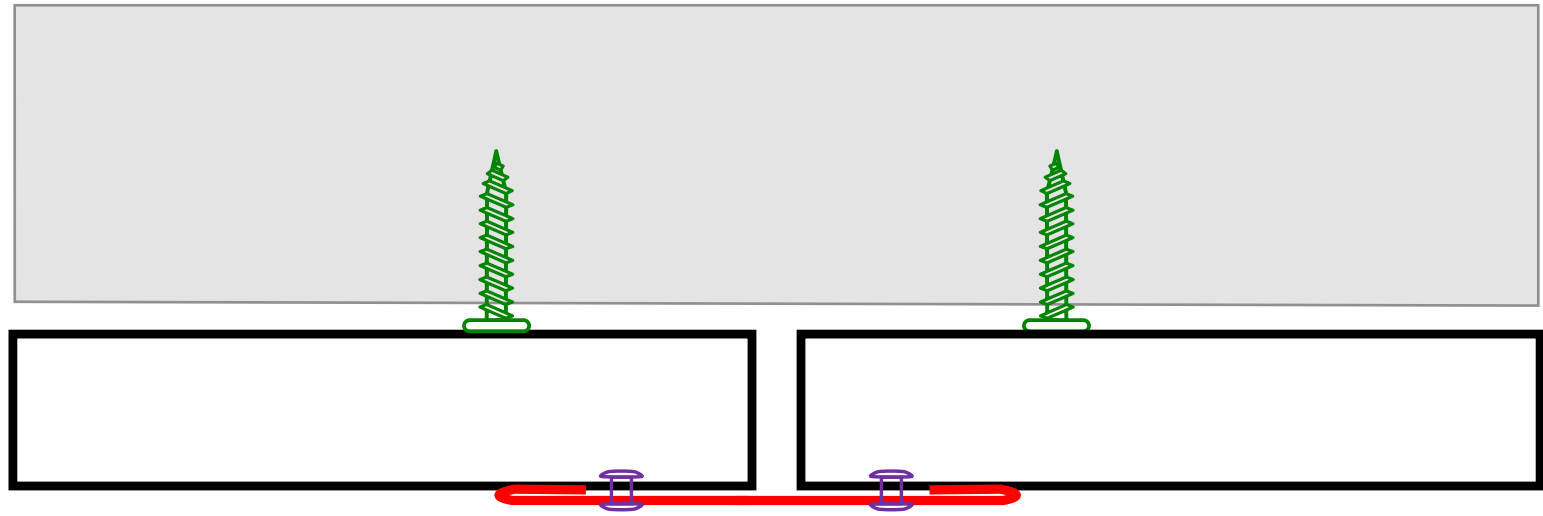

- 1) Install J-Channel using Pancake Screws.
- 2) Install Soffit Panels, either horizontally or vertically, tucking them inside the J-Channel, and fastening them with Pancake Screws.
- 3) Install Soffit Narrow Angle over end, capping the end of the shingles and going up the fascia, and fastening with Wood Screws.

Color Guide

-  Panel
-  J-Channel
-  Soffit Narrow Angle
-  Pancake Screw
-  Wood Screw

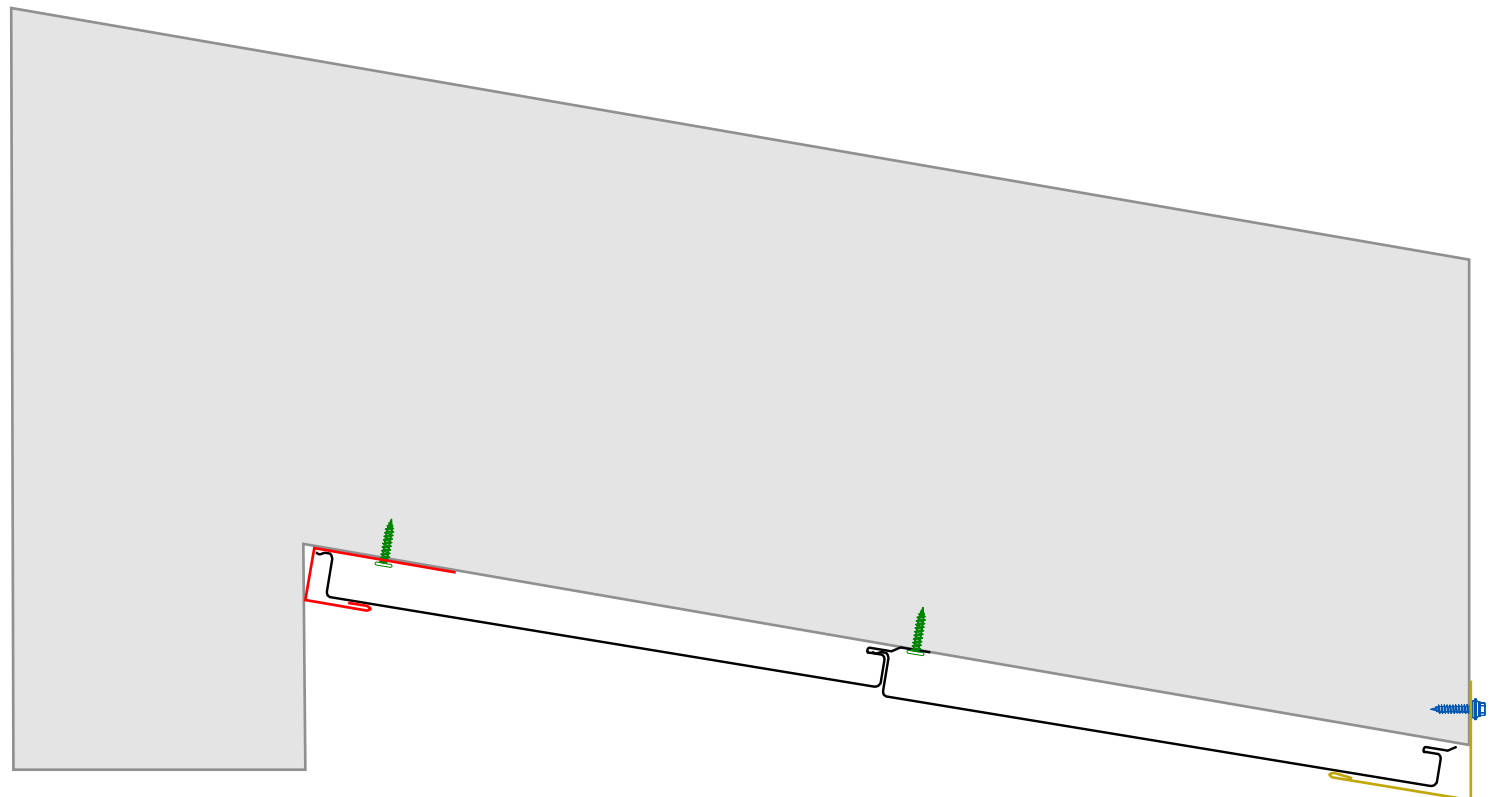



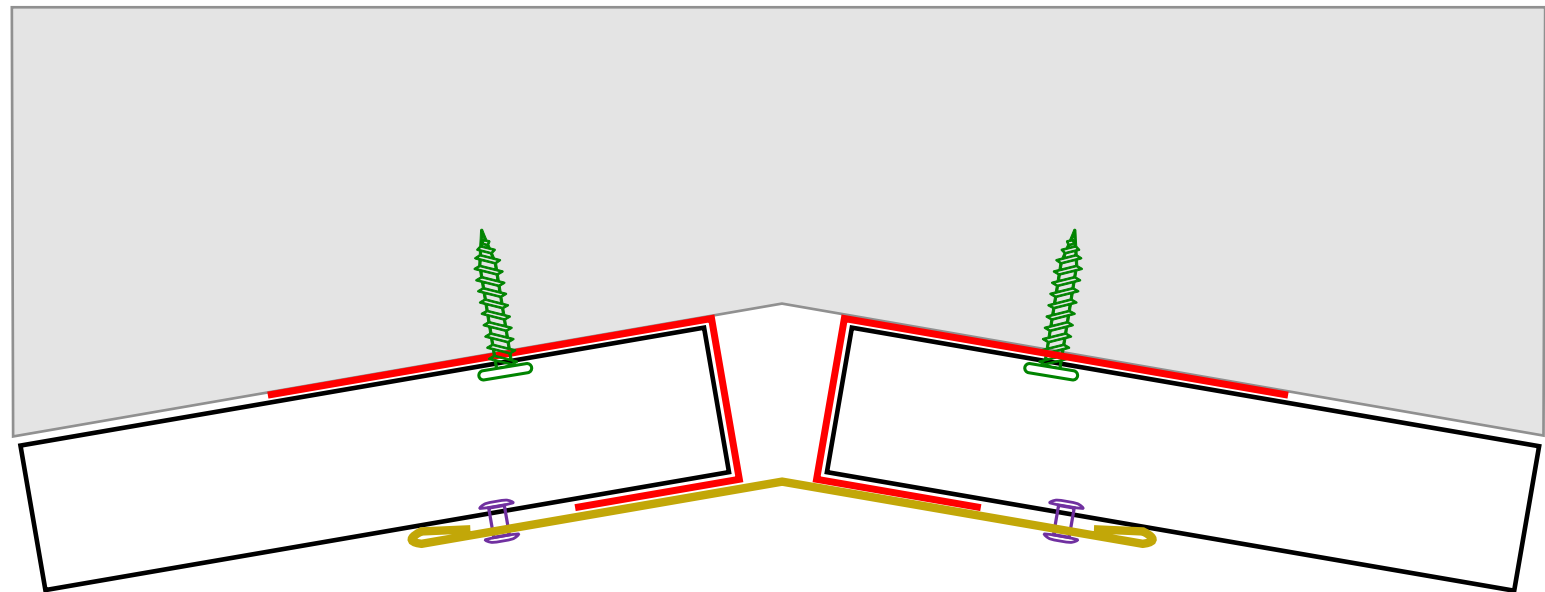
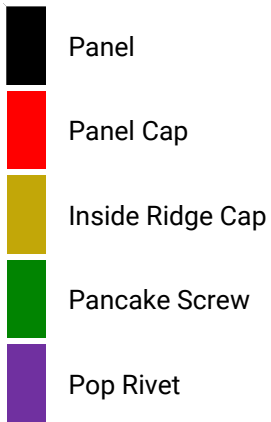

- 1) Optionally install Panel Caps on each side of inside ridge using Pancake Screws.
- 2) Install Soffit Panels, either horizontally or vertically, tucking them inside the Panel Caps (if used), and fastening them with Pancake Screws.
- 3) Install Inside Ridge Cap over panels and fasten with pop rivets.

Color Guide



- 1) Optionally install Panel Caps on each side of inside corner using Pancake Screws.
- 2) Install Soffit Panels, either horizontally or vertically, tucking them inside the Panel Caps (if used), and fastening them with Pancake Screws.
- 3) Install Inside Corner over panels and fasten with pop rivets.



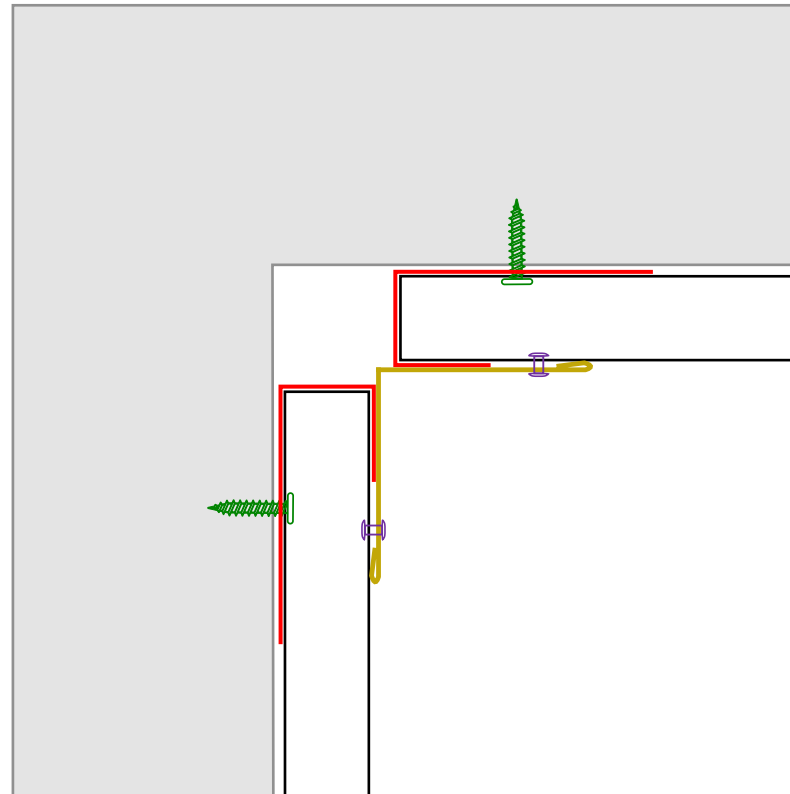

Color Guide

-  Panel
-  Panel Cap
-  Inside Corner
-  Pancake Screw
-  Pop Rivet



- 1) Optionally install Panel Caps on each side of outside corner.
- 2) Install Soffit Panels, either horizontally or vertically, tucking them inside the Panel Caps (if used), and fastening them with Pancake Screws.
- 3) Install Outside Corner over panels and fasten with pop rivets.

Color Guide

-  Panel
-  Panel Cap
-  Outside Corner
-  Pancake Screw
-  Pop Rivet

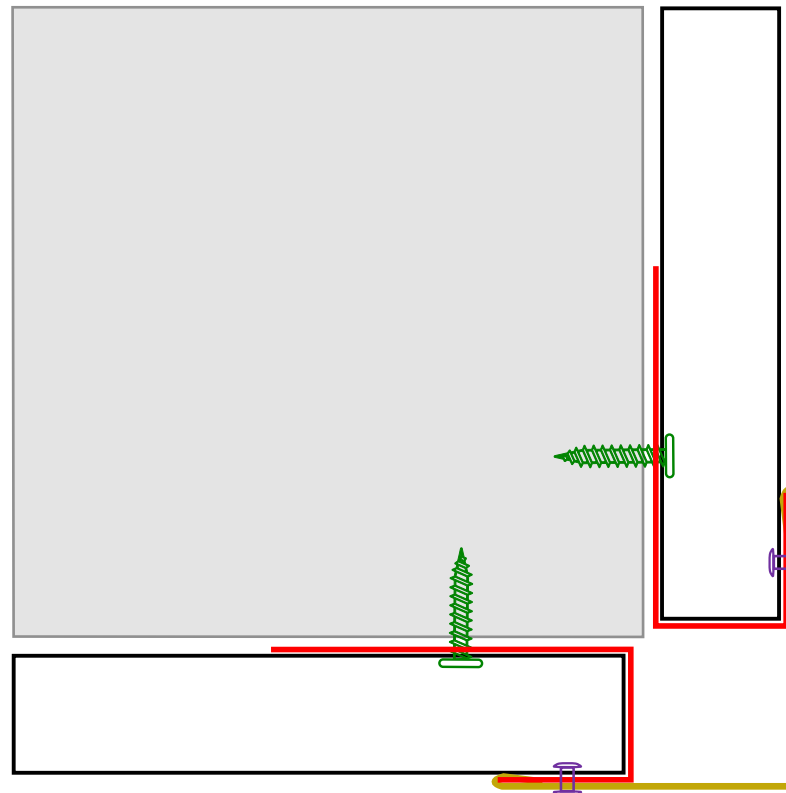

- 1) For bottom and sides of window (or sides of door) install J-Trim against window or door using Pancake Screws.
- 2) For top of window, install Soffit Base Trim (or Base Trim).
- 3) Install Soffit Panels around window or door, tucking them into the J-Trim at the sides and bottom, and butting them against the top of the Soffit Base Trim (or Base Trim) above the window or door

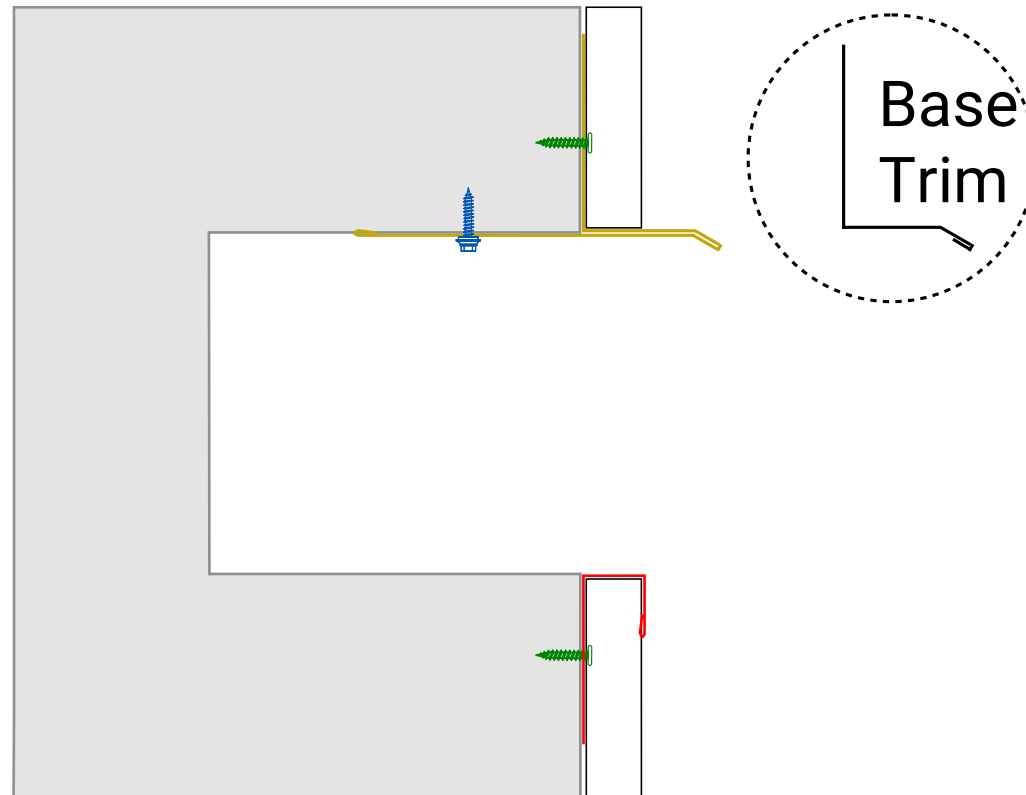

Color Guide

- Panel
- J-Trim
- Soffit Base Trim
- Pancake Screw
- Wood Screw



- 1) Install Base Trim using Pancake Screws.
- 2) Install Soffit Panels.

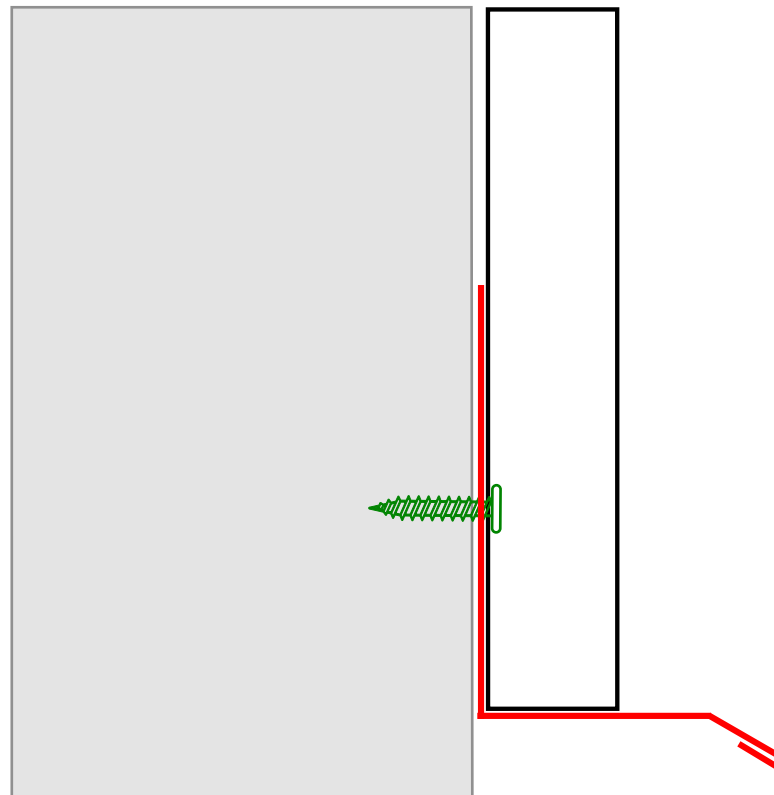

Color Guide

-  Panel
-  Base Trim
-  Pancake Screw



- 1) Install Rat Guard using Pancake Screws.
- 2) Install Soffit Panels.

Color Guide

-  Panel
-  Rat Guard
-  Pancake Screw

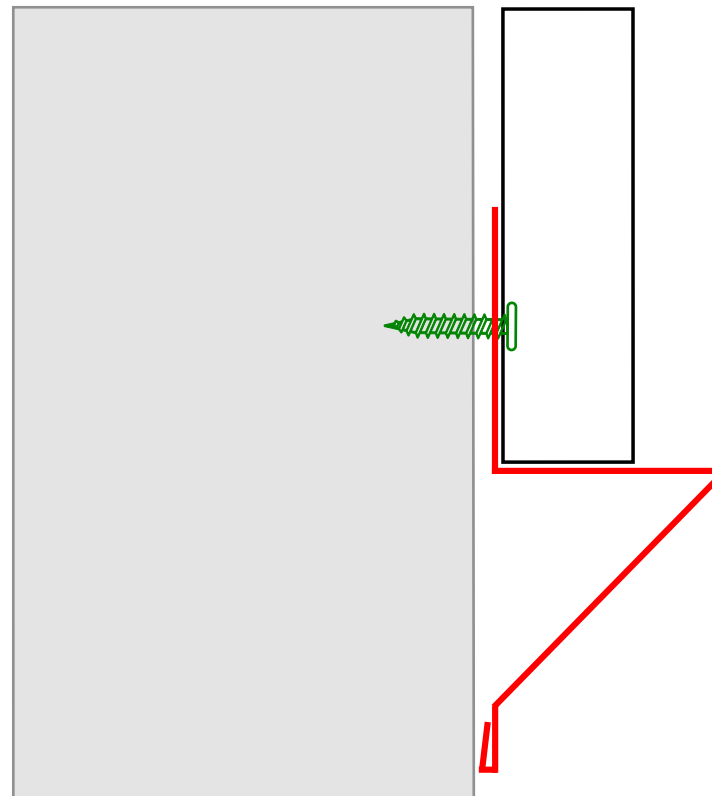



Metal Roofing, Nationwide

800-728-4010
bestbuymetals.com